

0/1-10V RF + Push Dimmer

Model No.: L1

RF dimming/0-10V or 1-10V/AC relay output/AC Push-Dim/Wall junction box mounting



CE RoHS LVD

Features

- 0/1-10V RF or AC push dimmer, 1 channel output.
- Output 1 channel 0/1-10V signal, connect with 0/1-10V dimmable driver.
- High voltage AC input, High voltage AC relay output.
- 0-10V or 1-10V output selectable by DIP switch.
- 256 levels 0-100% dimming smoothly without any flash.
- Compatibility with RF 2.4G single zone or multiple zone dimming remote control.
- Connect with external push switch to achieve on/off and 0-100% dimming function.
- Light on/off fade time 3s selectable.
- Easy to be placed in standard wall junction box behind a push switch.

Technical Parameters

Input and Output	
Input voltage	AC100-240V
Output signal	0/1-10V (20mA)
Output current	Max 1.5A (AC)
Dimming data	
Input signal	RF 2.4GHz + Push Dim
RF Control distance	30m(Barrier-free space)
Dimming level	256 levels
Dimming range	0-100%
Warranty	
Warranty	5 years

Safety and EMC	
EMC standard (EMC)	ETSI EN 301 489-1 V2.2.3 ETSI EN 301 489-17 V3.2.4
Safety standard(LVD)	EN 62368-1:2020+A11:2020
Radio Equipment(RED)	ETSI EN 300 328 V2.2.2
Certification	CE,EMC,LVD,RED
Environment	
Operation temperature	Ta: -30°C ~ +55°C
Case temperature (Max.)	Tc: +65°C
IP rating	IP20

Mechanical Structures and Installations

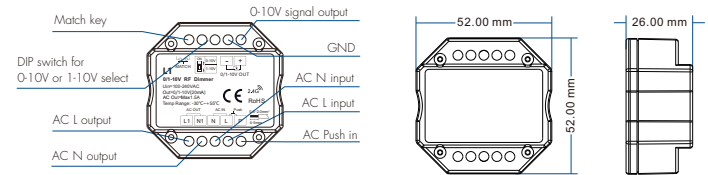

Typical Wall Junction Box Mounting

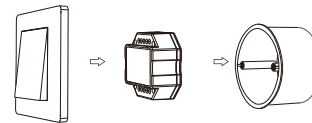

Wiring diagram

- Connect with 0/1-10V dimming driver (no use AC OUT)

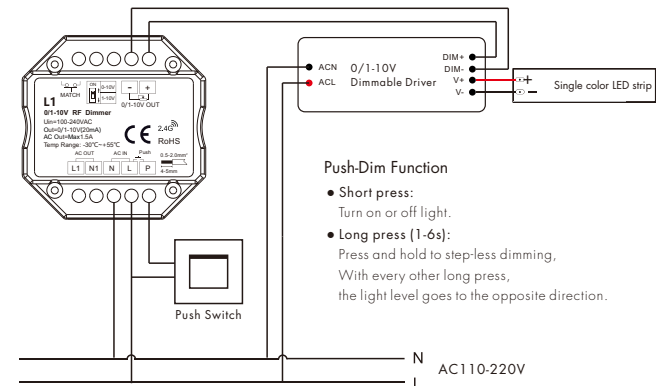

- Connect with 0/1-10V dimming driver (use AC OUT)

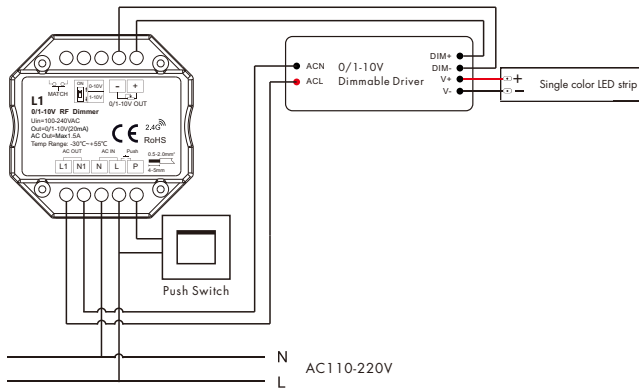

- Connect with 0/1-10V dimming driver (use AC OUT and relay or contactor)

An additional AC relay or contactor is needed when total input current of the load is higher than 1.5A or inrush current is greater than 15A.

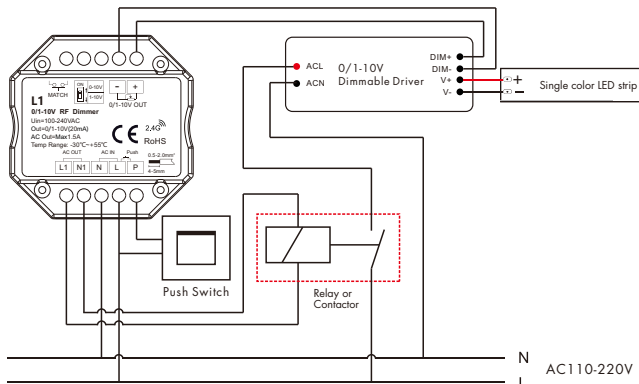

Note: We recommend the number of LED drivers connected to 0/1-10V dimmer does not exceed 50 pieces, The maximum length of the wires from dimmer to LED driver should be no more than 50 meters.

0-10V or 1-10V dimming setting

Select 0-10V dimmer or 1-10V dimmer according to dimmable LED driver.

0-10V Dimmer

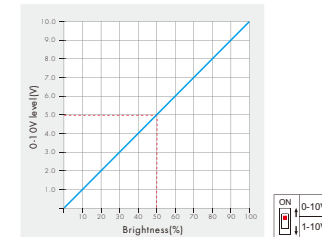

1-10V Dimmer

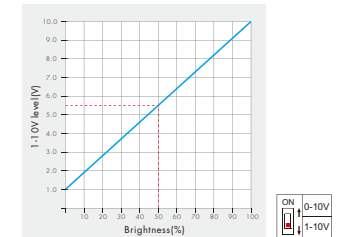

Note:

When the output channel is off, the output dimming signal is 0V or 1V. Please read the dimming section of the dimming driver manual. If the dimming characteristic curve is the same as right, you must select 1-10V dimmer and use AC OUT function, otherwise you can't turn off the lights.

Light on/off fade time

Long press match key 5s, then short press match key 3 times, the light on/off time will be set to 3s, the indicator light blink 3 times.

Long press match key 10s, restore factory default parameter, the light on/off time also restore to 0.5s.

Match Remote Control (two match ways)

End user can choose the suitable match/delete ways. Two options are offered for selection:

Use the controller's Match key

Match:

Short press match key, immediately press on/off key (single zone remote) or zone key (multiple zone remote) of the remote.

Delete:

Press and hold match key for 5s to delete all match, The light blinks 5 times means all matched remotes were deleted.

Use Power Restart

Match:

Switch off the power, then switch on power, repeat again. Immediately short press on/off key (single zone remote) or zone key (multiple zone remote) 3 times on the remote. The light blinks 3 times means match is successful.

Delete:

Switch off the power, then switch on power, repeat again. Immediately short press on/off key (single zone remote) or zone key (multiple zone remote) 5 times on the remote. The light blinks 5 times means all matched remotes were deleted.